



Vehicle History Report™

**2015 MERCEDES-BENZ
M-CLASS ML 350
4MATIC**

VIN: 4JGDA5HB4FA472265
4 DOOR WAGON/SPORT
UTILITY
3.5L V6 F DOHC 24V
GASOLINE
ALL WHEEL DRIVE

Minor to moderate damage

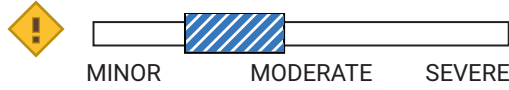

19 Service history records

3 Previous owners

Types of owners: Personal lease, Personal

148,596 Last reported odometer reading



This CARFAX Vehicle History Report is based only on information supplied to CARFAX and available as of 11/3/24 at 12:55:00 PM (CST). Other information about this vehicle, including problems, may not have been reported to CARFAX. Use this report as one important tool, along with a vehicle inspection and test drive, to make a better decision about your next used car.



Accident / Damage History

Not all accidents / issues are reported to CARFAX

Event 1

12/28/2015

**Accident reported:
minor damage**

- Vehicle involved in a rear-end collision with another vehicle

Damage Severity Scale

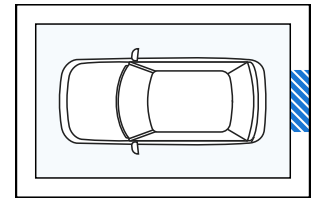
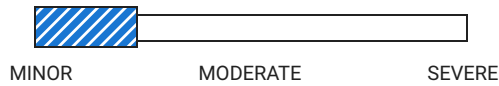

Event 2

05/02/2017

**Damage reported: minor
damage**

Damage Severity Scale

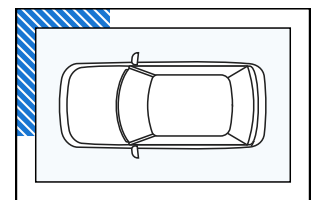
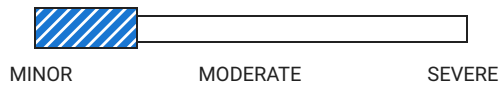

Event 3

12/18/2018

**Accident reported:
minor damage**
- Airbags did not deploy

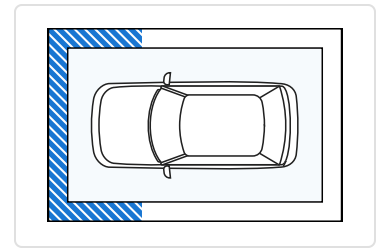
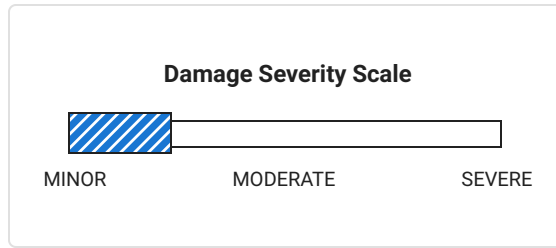

Event 4

01/07/2020

**Damage reported: minor
to moderate damage**
- Damage to undercarriage

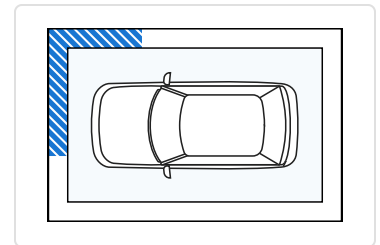
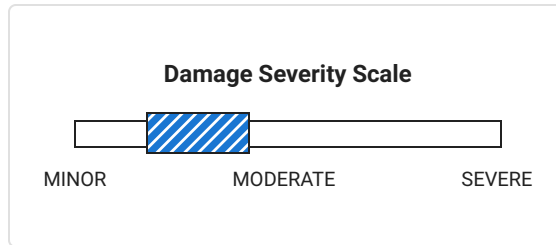

Event 5

09/09/2022

**Damage reported: minor
damage**

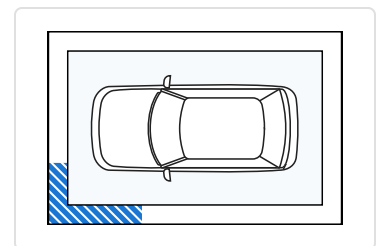
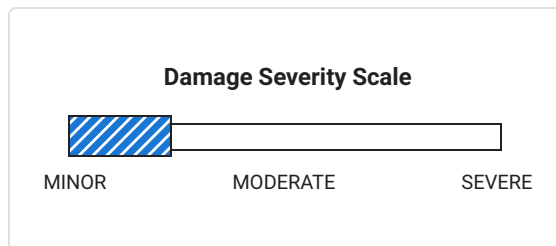

Event 6

05/03/2024

**Accident reported:
minor damage**
- Airbags did not deploy

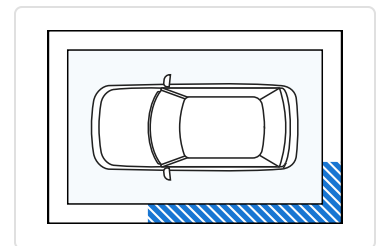
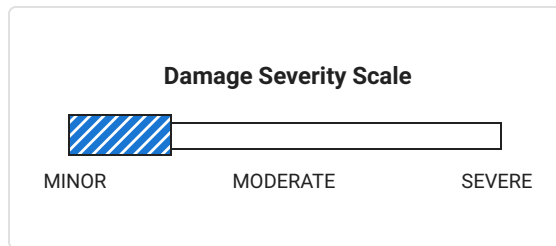

Additional History

Not all accidents / issues are reported to CARFAX

Owner 1

Owner 2

Owner 3

Total Loss

No total loss reported to CARFAX.

✓ No Issues Reported

✓ No Issues Reported

✓ No Issues Reported

Structural Damage CARFAX recommends that you have this vehicle inspected by a collision repair specialist.	<input checked="" type="checkbox"/> No Issues Reported	<input checked="" type="checkbox"/> No Issues Reported	<input checked="" type="checkbox"/> No Issues Reported
Airbag Deployment No airbag deployment reported to CARFAX.	<input checked="" type="checkbox"/> No Issues Reported	<input checked="" type="checkbox"/> No Issues Reported	<input checked="" type="checkbox"/> No Issues Reported
Odometer Check No indication of an odometer rollback.	<input checked="" type="checkbox"/> No Issues Indicated	<input checked="" type="checkbox"/> No Issues Indicated	<input checked="" type="checkbox"/> No Issues Indicated
Accident / Damage Accidents reported: 12/28/2015, 12/18/2018, and 05/03/2024. Damage reported: 05/02/2017, 01/07/2020, and 09/09/2022.	Accident Reported	No New Issues Reported	Accident Reported
Manufacturer Recall No open recalls reported to CARFAX.	<input checked="" type="checkbox"/> No Recalls Reported	<input checked="" type="checkbox"/> No Recalls Reported	<input checked="" type="checkbox"/> No Recalls Reported
Basic Warranty Original warranty estimated to have expired.	Warranty Expired	Warranty Expired	Warranty Expired

 Title History CARFAX guarantees the information in this section	Owner 1	Owner 2	Owner 3
Damage Brands Salvage Junk Rebuilt Fire Flood Hail Lemon	<input checked="" type="checkbox"/> Guaranteed No Problem	<input checked="" type="checkbox"/> Guaranteed No Problem	<input checked="" type="checkbox"/> Guaranteed No Problem
Odometer Brands Not Actual Mileage Exceeds Mechanical Limits	<input checked="" type="checkbox"/> Guaranteed No Problem	<input checked="" type="checkbox"/> Guaranteed No Problem	<input checked="" type="checkbox"/> Guaranteed No Problem

GUARANTEED - None of these title problems were reported by a U.S. state Department of Motor Vehicles (DMV). If you find that any of these title problems were reported by a DMV and not included in this report, you may qualify.
[View Terms](#) | [View Certificate](#)

 Ownership History The number of owners is estimated	Owner 1	Owner 2	Owner 3
Year purchased	2015	2018	2018
Type of owner	Personal lease	Personal	Personal
Estimated length of ownership	3 yrs. 4 mo.	1 month	6 yrs. 1 mo.
Owned in the following states/provinces	New York, Massachusetts	Massachusetts	Massachusetts
Estimated miles driven per year	9,579/yr	---	19,222/yr
Last reported odometer reading	33,170	34,128	148,596



Detailed History



Owner 1

Purchased: 2015



Low mileage! This owner drove less than the industry average of 15,000 miles per year.

Personal Lease
Vehicle
9,579 mi/yr

Date	Mileage	Source	Comments
09/09/2014	5	Mercedes-Benz of White Plains White Plains, NY 914-949-4000 4.7 / 5.0 607 Verified Reviews 1,126 Customer Favorites	Vehicle offered for sale
09/11/2014	7	Mercedes-Benz of White Plains White Plains, NY 914-949-4000 4.7 / 5.0 607 Verified Reviews 1,126 Customer Favorites	Vehicle serviced - Pre-delivery inspection completed - Tire condition and pressure checked
12/02/2014	27	Mercedes-Benz of White Plains White Plains, NY 914-949-4000 4.7 / 5.0 607 Verified Reviews 1,126 Customer Favorites	Vehicle serviced - Vehicle washed/detailed - Safety inspection performed - Emissions or safety inspection performed
12/02/2014		New York Inspection Station	Passed safety inspection - Passed emissions inspection
01/05/2015		New York Motor Vehicle Dept. White Plains, NY	Title issued or updated - Registration issued or renewed - Titled or registered as personal lease vehicle - Loan or lien reported - Passed safety inspection
02/28/2015	897	Mercedes-Benz of White Plains White Plains, NY 914-949-4000 4.7 / 5.0 607 Verified Reviews	Vehicle serviced

 **1,126** Customer Favorites

03/25/2015 2,912

Mercedes-Benz of White Plains
White Plains, NY
914-949-4000

 **4.7 / 5.0**

607 Verified Reviews

 **1,126** Customer Favorites



Vehicle serviced

- Maintenance inspection completed
- Body computer/module reprogrammed
- Battery charged
- Vehicle washed/detailed
- Tire condition and pressure checked
- Computer(s) checked
- Computer reprogrammed
- Wheel(s) replaced

03/27/2015

Dealer Inventory

Vehicle offered for sale

04/10/2015

Mercedes-Benz of White Plains
White Plains, NY
914-949-4000

 **4.7 / 5.0**

607 Verified Reviews

 **1,126** Customer Favorites



Vehicle serviced

05/09/2015

New York
Inspection Station

Dealer had vehicle inspected to prepare it for sale

- Passed safety inspection
- Emissions inspection performed

05/11/2015 2,916

Mercedes-Benz of White Plains
White Plains, NY
914-949-4000

 **4.7 / 5.0**

607 Verified Reviews

 **1,126** Customer Favorites

Vehicle sold

05/11/2015

Mercedes-Benz of White Plains
White Plains, NY
914-949-4000

 **4.7 / 5.0**

607 Verified Reviews

 **1,126** Customer Favorites



Vehicle serviced

- Safety inspection performed
- Floor mats installed
- Emissions or safety inspection performed

05/11/2015

New York
Motor Vehicle Dept.
Staten Island, NY

Registration issued or renewed

- Titled or registered as personal lease vehicle
- Passed safety inspection

05/26/2015

New York
Motor Vehicle Dept.
Roanoke, TX

Title issued or updated

- First owner reported

- Titled or registered as personal lease vehicle
- Loan or lien reported



Two states? Vehicle leasing companies often title a car in one state but register it to be driven in another.

12/08/2015 11,045

Mercedes-Benz of White Plains
White Plains, NY
914-949-4000

★ 4.7 / 5.0
607 Verified Reviews
❤️ 1,126 Customer Favorites



Vehicle serviced

- Maintenance inspection completed
- Recommended maintenance performed
- Tire condition and pressure checked
- Wiper(s) replaced
- Front wiper blades/refills replaced

12/28/2015

Damage Report



Accident reported: minor damage

- Vehicle involved in a rear-end collision with another vehicle
- Damage to rear

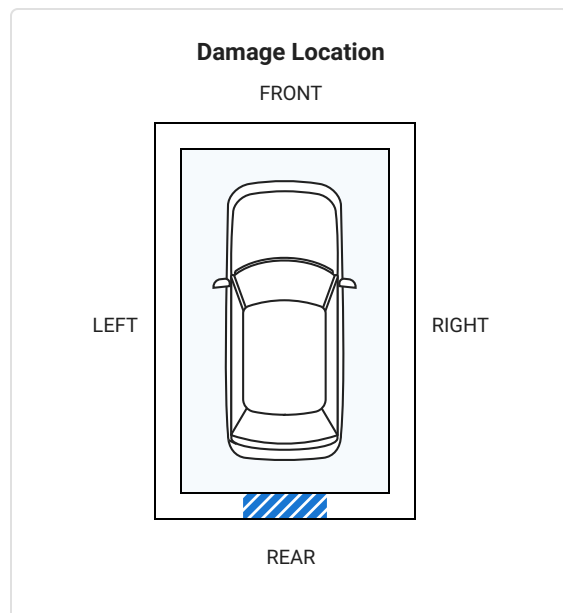
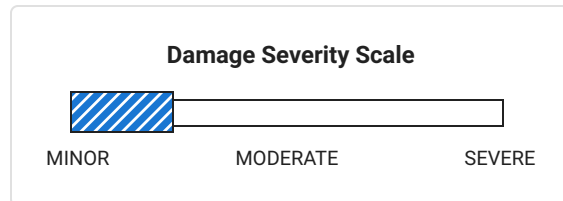

04/29/2016

New York
Motor Vehicle Dept.
Staten Island, NY

Registration issued or renewed

- Titled or registered as personal lease vehicle
- Passed safety inspection

05/02/2016

Mercedes-Benz of White Plains



Vehicle serviced

- Maintenance inspection completed

White Plains, NY
914-949-4000

★ 4.7 / 5.0
607 Verified Reviews
♥ 1,126 Customer Favorites

- Safety inspection performed
- Tire condition and pressure checked
- Emissions or safety inspection performed

05/02/2016 16,324

New York
Inspection Station

Passed safety inspection
- Emissions inspection performed

09/20/2016 22,730

Mercedes-Benz of White Plains
White Plains, NY
914-949-4000

★ 4.7 / 5.0
607 Verified Reviews
♥ 1,126 Customer Favorites



Vehicle serviced
- Maintenance inspection completed
- Recommended maintenance performed
- Brake fluid flushed/changed
- Tire condition and pressure checked
- Rear wiper blade replaced
- Front wiper blades/refills replaced

05/01/2017 26,613

Mercedes-Benz Manhattan
New York, NY
212-629-1600

★ 4.3 / 5.0
510 Verified Reviews
♥ 387 Customer Favorites



Vehicle serviced

05/02/2017

Damage Report



Damage reported: minor damage
- Damage to front
- Damage to right front

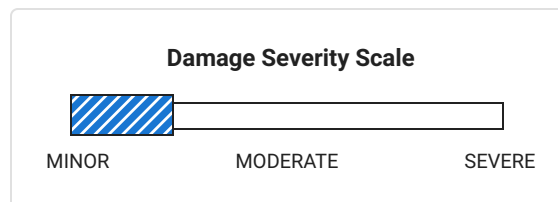

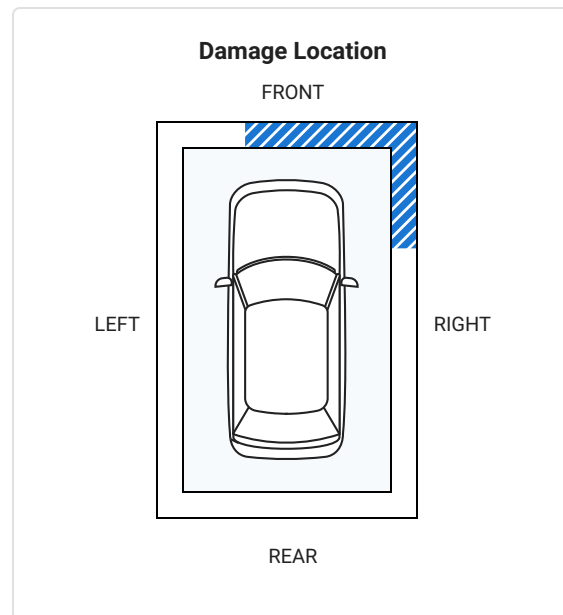

06/01/2017 27,468

New York
Inspection Station

Passed safety inspection
- Passed emissions inspection

01/11/2018 31,527

Mercedes-Benz of White
Plains
White Plains, NY
914-949-4000



Vehicle serviced
- Maintenance inspection completed
- Recommended maintenance performed
- Tire condition and pressure checked
- Rear wiper blade replaced
- Front wiper blades/refills replaced

★ **4.7 / 5.0**
607 Verified Reviews
♥ **1,126** Customer Favorites

05/28/2018 33,148

Mercedes-Benz Financial
Services

Vehicle sold at auction



Millions of used vehicles are bought and sold at auction every year.

05/29/2018

Automax Preowned
Marlborough, MA
508-370-9600

Vehicle offered for sale

★ **3.7 / 5.0**
40 Verified Reviews

07/05/2018

Automax Framingham
Framingham, MA
508-370-9600

Vehicle sold

★ **3.2 / 5.0**
56 Verified Reviews
♥ **2** Customer Favorites

07/05/2018

Massachusetts
Motor Vehicle Dept.

Vehicle purchase reported

07/09/2018		Massachusetts Motor Vehicle Dept. Lancaster, MA	Registration issued or renewed - Loan or lien reported - Vehicle color noted as Black
07/10/2018	33,170	Massachusetts Inspection Station Framingham, MA	Passed safety inspection - Passed emissions inspection



Owner 2
Purchased: 2018



Personal Vehicle

Date	Mileage	Source	Comments
07/27/2018		Massachusetts Motor Vehicle Dept. Lancaster, MA	Title issued or updated - New owner reported - Loan or lien reported - Vehicle color noted as Black
07/28/2018	34,128	Inspection Co. Massachusetts	Inspection performed



Owner 3
Purchased: 2018

Personal Vehicle
19,222 mi/yr

Date	Mileage	Source	Comments
09/12/2018	35,000	Massachusetts Motor Vehicle Dept.	Vehicle purchase reported
11/06/2018	41,096	Wagner Mercedes-Benz of Shrewsbury Shrewsbury, MA 508-581-5600 ★ 4.3 / 5.0 44 Verified Reviews	 Vehicle serviced - Oil and filter changed - Tire condition and pressure checked
11/09/2018		Massachusetts Motor Vehicle Dept. Lancaster, MA	Registration issued or renewed - Loan or lien reported - Vehicle color noted as Black
11/23/2018		Massachusetts Motor Vehicle Dept. Lancaster, MA	Title issued or updated - New owner reported - Loan or lien reported - Vehicle color noted as Black
12/18/2018		Damage Report	 Accident reported: minor damage - Damage to front - Damage to left front - Damage to right front - Airbags did not deploy

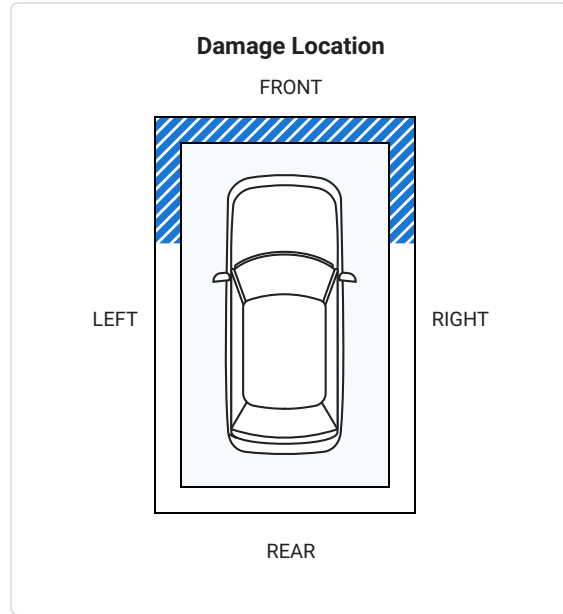
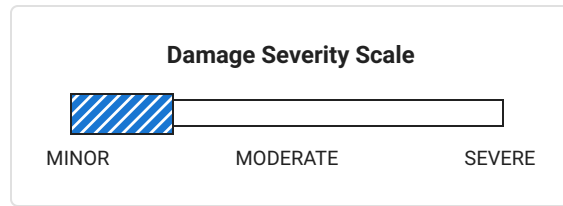



07/23/2019 56,415 Massachusetts Inspection Station Clinton, MA **Passed safety inspection**
- Passed emissions inspection

11/07/2019 Massachusetts Motor Vehicle Dept. Lancaster, MA **Registration issued or renewed**
- Loan or lien reported
- Vehicle color noted as Black

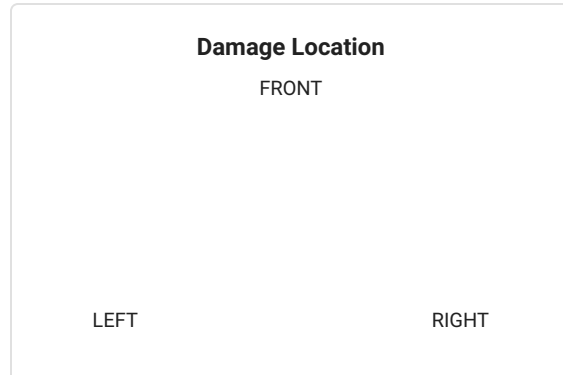
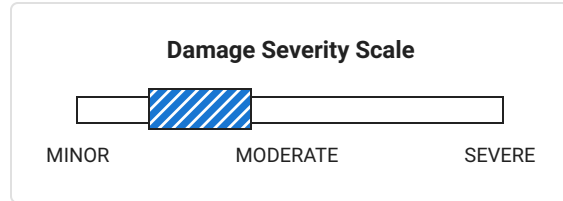
01/07/2020 Damage Report **Damage reported: minor to moderate damage**
- Damage to right front
- Damage to front
- Damage to undercarriage

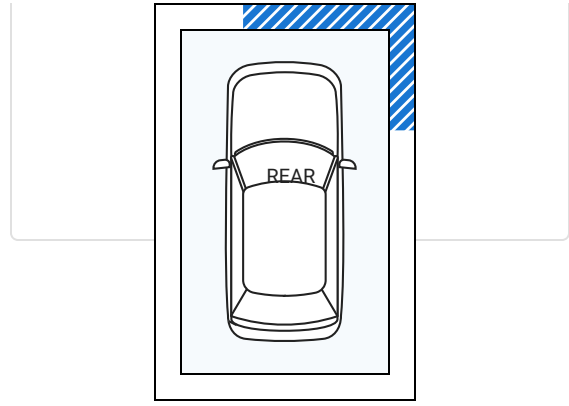

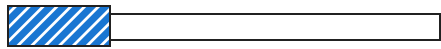

07/30/2020	72,949	Massachusetts Inspection Station Clinton, MA	Passed safety inspection - Passed emissions inspection
01/02/2021		Massachusetts Motor Vehicle Dept. Lancaster, MA	Registration issued or renewed - Loan or lien reported - Vehicle color noted as Black
09/15/2021	90,736	Massachusetts Inspection Station Clinton, MA	Passed safety inspection - Passed emissions inspection
12/02/2021		Massachusetts Motor Vehicle Dept. Lancaster, MA	Registration issued or renewed - Loan or lien reported - Vehicle color noted as Black
08/12/2022	110,285	Valvoline Instant Oil Change Leominster, MA 978-466-9757 ★ 4.3 / 5.0 184 Verified Reviews ❤️ 140 Customer Favorites	 Vehicle serviced - Oil and filter changed
09/09/2022		Damage Report	 Damage reported: minor damage - Damage to left front <div data-bbox="846 1738 1412 1942"><p>Damage Severity Scale</p><p>MINOR MODERATE SEVERE</p></div> <div data-bbox="846 1953 1412 2020"><p>Damage Location</p></div>

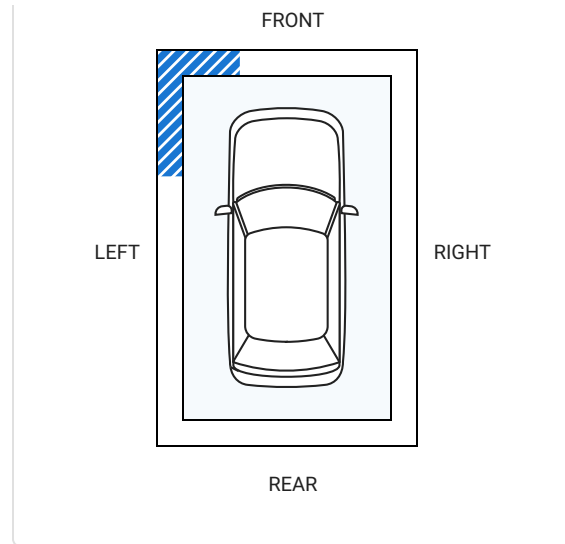

09/22/2022	112,316	A & B Tire Service Leominster, MA 978-537-2722		Vehicle serviced - Tire(s) balanced - Four tires mounted - Tire condition and pressure checked - Four tires balanced
		★ 4.9 / 5.0 104 Verified Reviews ♥ 14 Customer Favorites		
11/02/2022	112,995	Massachusetts Inspection Station Clinton, MA	Passed safety inspection - Failed emissions inspection	
11/02/2022	Main Street Automotive Services Center Clinton, MA 978-368-7211			Vehicle serviced
		★ 5.0 / 5.0 92 Verified Reviews ♥ 21 Customer Favorites		
11/03/2022	113,013	A & B Tire Service Leominster, MA 978-537-2722		Vehicle serviced - Rear brake rotor(s) replaced - Brake pad sensor(s) replaced - Rear brake pads replaced - Front brake rotor(s) replaced - Front brake pads replaced
		★ 4.9 / 5.0 104 Verified Reviews ♥ 14 Customer Favorites		
12/01/2022	Massachusetts Motor Vehicle Dept. Lancaster, MA		Registration issued or renewed - Loan or lien reported - Vehicle color noted as Black	
02/06/2023	Main Street Automotive Services Center Clinton, MA 978-368-7211			Vehicle serviced - Emissions or safety inspection performed

★ 5.0 / 5.0

92 Verified Reviews

♥ 21 Customer Favorites

02/06/2023 119,169

Massachusetts
Inspection Station
Clinton, MA

Passed safety inspection
- Passed emissions inspection

12/01/2023

Massachusetts
Motor Vehicle Dept.
Lancaster, MA

Registration issued or renewed
- Loan or lien reported
- Vehicle color noted as Black

01/30/2024

Main Street Automotive
Services Center
Clinton, MA
978-368-7211



Vehicle serviced
- Emissions or safety inspection
performed

★ 5.0 / 5.0

92 Verified Reviews

♥ 21 Customer Favorites

01/30/2024 136,275

Massachusetts
Inspection Station
Clinton, MA

Passed safety inspection
- Passed emissions inspection

05/03/2024

Damage Report



Accident reported: minor damage
- Damage to left rear
- Damage to left side
- Airbags did not deploy



Damage Severity Scale

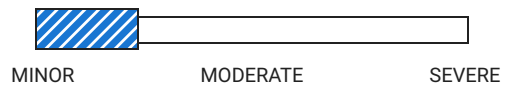

Damage Location

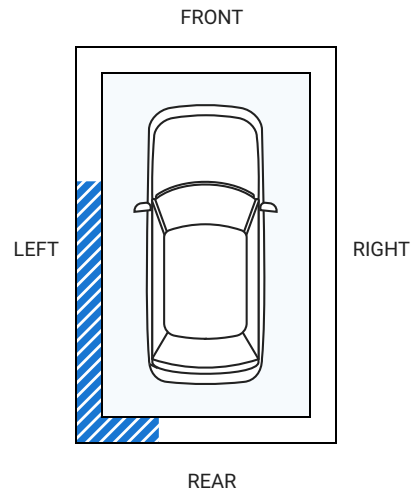

05/28/2024	Massachusetts Motor Vehicle Dept. Lancaster, MA	Registration issued or renewed - Vehicle color noted as Black
08/08/2024 148,596	Valvoline Instant Oil Change Leominster, MA 978-466-9757 ★ 4.3 / 5.0 184 Verified Reviews ❤️ 140 Customer Favorites	 Vehicle serviced - Oil and filter changed - Antifreeze/coolant flushed/changed

Have Questions? Please visit our Help Center at www.carfax.com.



Glossary

Accident Indicator

CARFAX receives information about accidents in all 50 states, the District of Columbia and Canada.

Not every accident is reported to CARFAX. As details about the accident become available, those additional details are added to the CARFAX Vehicle History Report. CARFAX recommends that you have this vehicle inspected by a qualified mechanic.

- According to the National Safety Council, Injury Facts, 2021 edition, 5% of the 276 million registered vehicles in the U.S. were involved in an accident in 2019. Over 77% of these were considered minor or moderate.
- This CARFAX Vehicle History Report is based only on information supplied to CARFAX and available as of 11/3/24 at 12:55:00 PM (CST). Other information about this vehicle, including problems, may not have been reported to CARFAX. Use this report as one important tool, along with a vehicle inspection and test drive, to make a better decision about your next used car.

Damage Indicator

Damage can be a result of many different types of events. Examples include contact with objects (other cars, trees, traffic signs, road debris, etc), vandalism, or weather-related events. Not every damage event is reported to CARFAX. As details about the damage event become available, those additional details are added to the CARFAX Vehicle History Report. CARFAX recommends that you have this vehicle inspected by a qualified mechanic.

- This CARFAX Vehicle History Report is based only on information supplied to CARFAX and available as of 11/3/24 at 12:55:00 PM (CST). Other information about this vehicle, including problems, may not have been reported to CARFAX. Use this report as one important tool, along with a vehicle inspection and test drive, to make a better decision about your next used car.

Damage Severity

Damage events result in one of the following severity levels:

- Minor: Generally, minor damage is cosmetic (including dents or scratches), may only require reconditioning, and typically does not compromise a vehicle's operation and/or safety.
- Moderate: Moderate damage may affect multiple components of the vehicle and may impair the vehicle's operation and/or safety.
- Severe: Severe damage usually affects multiple components of the vehicle and is likely to compromise the vehicle's operation and/or safety.

CARFAX recommends getting a pre-purchase inspection at a certified collision repair facility.

Failed Emissions Inspection

The emissions check performed during a vehicle inspection indicated the vehicle was emitting more than allowable emissions standards and/or had missing or modified parts. Repeated failed emissions records can indicate engine

problems and CARFAX recommends you have the vehicle inspected.

First Owner

When the first owner(s) obtains a title from a Department of Motor Vehicles as proof of ownership.

New Owner Reported

When a vehicle is sold to a new owner, the Title must be transferred to the new owner(s) at a Department of Motor Vehicles.

Ownership History

CARFAX defines an owner as an individual or business that possesses and uses a vehicle. Not all title transactions represent changes in ownership. To provide estimated number of owners, CARFAX proprietary technology analyzes all the events in a vehicle history. Estimated ownership is available for vehicles manufactured after 1991 and titled solely in the US including Puerto Rico. Dealers sometimes opt to take ownership of a vehicle and are required to in the following states: Maine, Massachusetts, New Jersey, Ohio, Oklahoma, Pennsylvania and South Dakota. Please consider this as you review a vehicle's estimated ownership history.

Title Issued

A state issues a title to provide a vehicle owner with proof of ownership. Each title has a unique number. Each title or registration record on a CARFAX report does not necessarily indicate a change in ownership. In Canada, a registration and bill of sale are used as proof of ownership.

Follow Us:



facebook.com/CARFAX



[@CARFAXinc](https://twitter.com/CARFAXinc)



About CARFAX

CARFAX DEPENDS ON ITS SOURCES FOR THE ACCURACY AND RELIABILITY OF ITS INFORMATION. THEREFORE, NO RESPONSIBILITY IS ASSUMED BY CARFAX OR ITS AGENTS FOR ERRORS OR OMISSIONS IN THIS REPORT. CARFAX FURTHER EXPRESSLY DISCLAIMS ALL WARRANTIES, EXPRESS OR IMPLIED, INCLUDING ANY IMPLIED WARRANTIES OF MERCHANTABILITY OR FITNESS FOR A PARTICULAR PURPOSE.

© 2024 CARFAX, Inc., part of S&P Global. All rights reserved.
11/3/24 12:55:00 PM (CST)

