

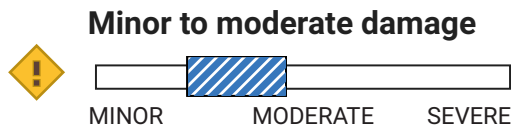

Vehicle History Report™

2007 MERCEDES-BENZ SL-CLASS SL 550

VIN: WDBSK71F57F123796
 CONVERTIBLE
 5.5L V8 F DOHC 32V
 GASOLINE
 REAR WHEEL DRIVE



17 Service history records

CARFAX 1-Owner vehicle

Personal vehicle

89,826 Last reported odometer reading

This CARFAX Vehicle History Report is based only on information supplied to CARFAX and available as of 11/14/23 at 10:20:47 PM (CST). Other information about this vehicle, including problems, may not have been reported to CARFAX. Use this report as one important tool, along with a vehicle inspection and test drive, to make a better decision about your next used car.

Ownership History The number of owners is estimated		Owner 1
Year purchased		2006
Type of owner		Personal
Estimated length of ownership		17 yrs. 2 mo.
Owned in the following states/provinces		California
Estimated miles driven per year		5,230/yr
Last reported odometer reading		89,826



Title History CARFAX guarantees the information in this section		Owner 1
Damage Brands Salvage Junk Rebuilt Fire Flood Hail Lemon		Guaranteed No Problem
Odometer Brands Not Actual Mileage Exceeds Mechanical Limits		Guaranteed No Problem



GUARANTEED - None of these title problems were reported by a U.S. state Department of Motor Vehicles (DMV). If you find that any of these title problems were reported by a DMV and not included in this report, you may qualify.
View Terms | View Certificate



 Additional History Not all accidents / issues are reported to CARFAX	Owner 1
Total Loss No total loss reported to CARFAX.	<input checked="" type="checkbox"/> No Issues Reported
Structural Damage CARFAX recommends that you have this vehicle inspected by a collision repair specialist.	<input checked="" type="checkbox"/> No Issues Reported
Airbag Deployment No airbag deployment reported to CARFAX.	<input checked="" type="checkbox"/> No Issues Reported
Odometer Check No indication of an odometer rollback.	<input checked="" type="checkbox"/> No Issues Indicated
Accident / Damage Damage reported: 07/01/2013 and 06/23/2020.	Damage Reported
Manufacturer Recall Check with an authorized Mercedes-Benz dealer for any open recalls.	<input checked="" type="checkbox"/> No Recalls Reported
Basic Warranty Original warranty estimated to have expired.	Warranty Expired

 **Detailed History**

 Owner 1 Purchased: 2006		<div style="border: 1px solid blue; padding: 5px;"> Low mileage! This owner drove less than the industry average of 15,000 miles per year. </div>	Personal Vehicle 5,230 mi/yr
---	---	--	---------------------------------

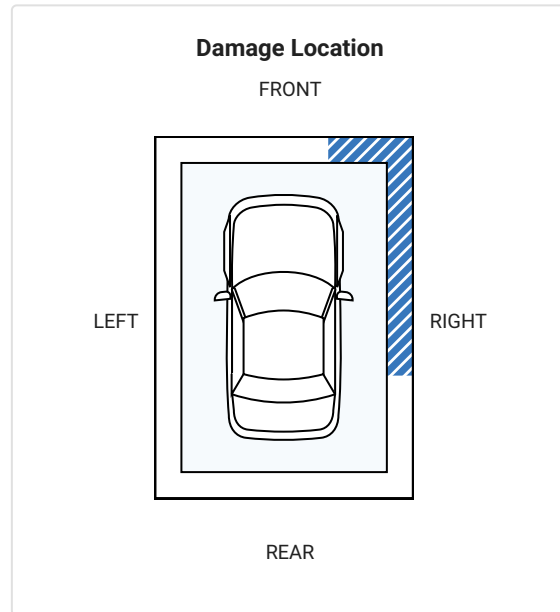
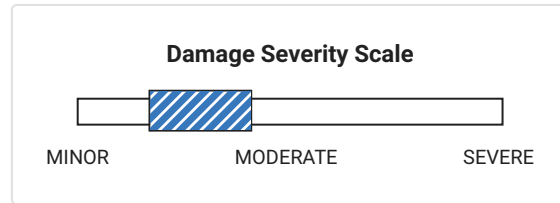
Date	Mileage	Source	Comments
08/23/2006	81	California Motor Vehicle Dept. San Diego, CA	Title issued or updated - First owner reported - Titled or registered as personal vehicle - Loan or lien reported
05/17/2007		California Motor Vehicle Dept. San Diego, CA	Title issued or updated
07/01/2013		Damage Report	 Damage reported: minor to moderate damage - Damage to right front - Damage to right side



07/16/2013	41,355	Mercedes-Benz of San Diego San Diego, CA 858-569-6900	 Vehicle serviced - Airbag system checked
		★ 4.6 / 5.0 659 Verified Reviews ❤️ 16,183 Customer Favorites	
09/09/2013	41,410	California Inspection Station La Mesa, CA	Passed emissions inspection
08/20/2015	52,120	California Inspection Station	Passed emissions inspection
07/18/2016	58,268	Clifton Mercedes Independent Sales & Service El Cajon, CA 619-401-7822	 Vehicle serviced - Transmission filter replaced
		★ 4.8 / 5.0 92 Verified Reviews ❤️ 762 Customer Favorites	
10/04/2016	59,503	Clifton Mercedes Independent Sales & Service El Cajon, CA 619-401-7822	 Vehicle serviced - Battery/charging system checked

★ 4.8 / 5.0

92 Verified Reviews

♥ 762 Customer Favorites

01/23/2017 64,026

Clifton Mercedes
Independent Sales &
Service
El Cajon, CA
619-401-7822**Vehicle serviced**

- Air filter replaced
- Oil and filter changed

★ 4.8 / 5.0

92 Verified Reviews

♥ 762 Customer Favorites

07/27/2017

California
Inspection Station**Passed emissions inspection**

10/20/2017 65,162

Clifton Mercedes
Independent Sales &
Service
El Cajon, CA
619-401-7822**Vehicle serviced**

- Oil and filter changed
- Transmission mount(s) replaced
- Fuel pump replaced

★ 4.8 / 5.0

92 Verified Reviews

♥ 762 Customer Favorites

04/03/2018 67,362

Clifton Mercedes
Independent Sales &
Service
El Cajon, CA
619-401-7822**Vehicle serviced**

- Oil and filter changed

★ 4.8 / 5.0

92 Verified Reviews

♥ 762 Customer Favorites

10/18/2018 68,321

Clifton Mercedes
Independent Sales &
Service
El Cajon, CA
619-401-7822**Vehicle serviced**

- Vehicle washed/detailed

★ 4.8 / 5.0

92 Verified Reviews

♥ 762 Customer Favorites

03/11/2019 69,021

Clifton Mercedes
Independent Sales &
Service
El Cajon, CA
619-401-7822**Vehicle serviced**

- Oil and filter changed
- Engine oil filler cap/seal replaced
- Vehicle washed/detailed
- Thermostat housing/gasket replaced

★ 4.8 / 5.0

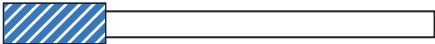

92 Verified Reviews

♥ 762 Customer Favorites

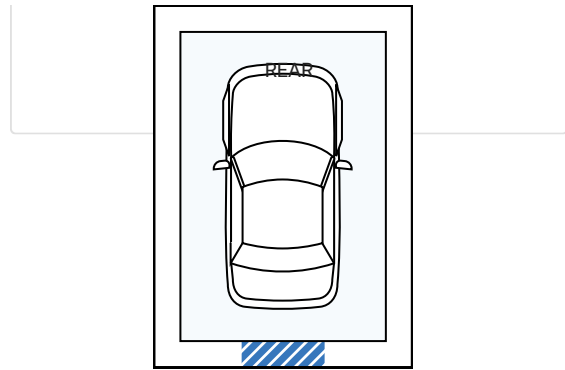
06/28/2019	72,829	Clifton Mercedes Independent Sales & Service El Cajon, CA 619-401-7822		Vehicle serviced - Vehicle washed/detailed
		★ 4.8 / 5.0 92 Verified Reviews ♥ 762 Customer Favorites		
07/24/2019	73,398	California Inspection Station	Passed emissions inspection	
08/19/2019	73,560	Clifton Mercedes Independent Sales & Service El Cajon, CA 619-401-7822		Vehicle serviced - Battery replaced - Battery/charging system checked
		★ 4.8 / 5.0 92 Verified Reviews ♥ 762 Customer Favorites		
03/17/2020	76,041	Clifton Mercedes Independent Sales & Service El Cajon, CA 619-401-7822		Vehicle serviced - Rear brake pads replaced - Oil and filter changed - Brakes serviced - Battery/charging system checked - Brake pads replaced - Brake fluid flushed/changed - Battery replaced
		★ 4.8 / 5.0 92 Verified Reviews ♥ 762 Customer Favorites		
06/23/2020	Damage Report			Damage reported: minor damage - Damage to rear
<p style="text-align: center;">Damage Severity Scale</p>  <p style="text-align: center;">MINOR MODERATE SEVERE</p>				
<p style="text-align: center;">Damage Location</p> <p style="text-align: center;">FRONT</p> <p style="text-align: center;">LEFT RIGHT</p>				



04/19/2021	79,573	Clifton Mercedes Independent Sales & Service El Cajon, CA 619-401-7822		Vehicle serviced - Oil and filter changed - Transmission mount(s) replaced
		★ 4.8 / 5.0 92 Verified Reviews ♥ 762 Customer Favorites		
07/06/2021	80,446	California Inspection Station	Passed emissions inspection	
11/08/2021	81,829	Clifton Mercedes Independent Sales & Service El Cajon, CA 619-401-7822		Vehicle serviced - Cup holder replaced - Transmission mount(s) replaced - Starter replaced - Engine mount(s) replaced - Tailgate/trunk lock replaced
		★ 4.8 / 5.0 92 Verified Reviews ♥ 762 Customer Favorites		
02/11/2022	82,948	Clifton Mercedes Independent Sales & Service El Cajon, CA 619-401-7822		Vehicle serviced - Vehicle washed/detailed
		★ 4.8 / 5.0 92 Verified Reviews ♥ 762 Customer Favorites		
08/15/2022	84,659	Clifton Mercedes Independent Sales & Service El Cajon, CA		Vehicle serviced - Oil and filter changed - Steering/suspension checked

		619-401-7822	
		★ 4.8 / 5.0	
		92 Verified Reviews	
		♥ 762 Customer Favorites	
06/22/2023	88,982	California Inspection Station	Passed emissions inspection
10/02/2023	89,635	Clifton Mercedes Independent Sales & Service El Cajon, CA 619-401-7822	 Vehicle serviced - Oil and filter changed - Brakes serviced - Brake fluid flushed/changed - Brakes checked
		★ 4.8 / 5.0	
		92 Verified Reviews	
		♥ 762 Customer Favorites	
10/16/2023	89,826	Clifton Mercedes Independent Sales & Service El Cajon, CA 619-401-7822	 Vehicle serviced - Radiator checked - Cooling system hoses checked - Coolant reservoir replaced - Wiper(s) replaced - Radiator cap replaced
		★ 4.8 / 5.0	
		92 Verified Reviews	
		♥ 762 Customer Favorites	
10/25/2023		California Motor Vehicle Dept. San Diego, CA	Title issued or updated - Duplicate title issued

Have Questions? Please visit our Help Center at www.carfax.com.



Glossary

Damage Indicator

Damage can be a result of many different types of events. Examples include contact with objects (other cars, trees, traffic signs, road debris, etc), vandalism, or weather-related events. Not every damage event is reported to CARFAX. As details about the damage event become available, those additional details are added to the CARFAX Vehicle History Report. CARFAX recommends that you have this vehicle inspected by a qualified mechanic.

- This CARFAX Vehicle History Report is based only on information supplied to CARFAX and available as of 11/14/23 at 10:20:47 PM (CST). Other information about this vehicle, including problems, may not have been reported to CARFAX. Use this report as one important tool, along with a vehicle inspection and test drive, to make a better decision about your next used car.

Damage Severity

Damage events result in one of the following severity levels:

- **Minor:** Generally, minor damage is cosmetic (including dents or scratches), may only require reconditioning, and typically does not compromise a vehicle's operation and/or safety.
- **Moderate:** Moderate damage may affect multiple components of the vehicle and may impair the vehicle's operation and/or safety.
- **Severe:** Severe damage usually affects multiple components of the vehicle and is likely to compromise the vehicle's operation and/or safety.

CARFAX recommends getting a pre-purchase inspection at a certified collision repair facility.

First Owner



When the first owner(s) obtains a title from a Department of Motor Vehicles as proof of ownership.

Ownership History

CARFAX defines an owner as an individual or business that possesses and uses a vehicle. Not all title transactions represent changes in ownership. To provide estimated number of owners, CARFAX proprietary technology analyzes all the events in a vehicle history. Estimated ownership is available for vehicles manufactured after 1991 and titled solely in the US including Puerto Rico. Dealers sometimes opt to take ownership of a vehicle and are required to in the following states: Maine, Massachusetts, New Jersey, Ohio, Oklahoma, Pennsylvania and South Dakota. Please consider this as you review a vehicle's estimated ownership history.

Title Issued

A state issues a title to provide a vehicle owner with proof of ownership. Each title has a unique number. Each title or registration record on a CARFAX report does not necessarily indicate a change in ownership. In Canada, a registration and bill of sale are used as proof of ownership.

Follow Us:  [facebook.com/CARFAX](https://www.facebook.com/CARFAX)  [@CARFAXinc](https://twitter.com/CARFAXinc)  **About CARFAX**

CARFAX DEPENDS ON ITS SOURCES FOR THE ACCURACY AND RELIABILITY OF ITS INFORMATION. THEREFORE, NO RESPONSIBILITY IS ASSUMED BY CARFAX OR ITS AGENTS FOR ERRORS OR OMISSIONS IN THIS REPORT. CARFAX FURTHER EXPRESSLY DISCLAIMS ALL WARRANTIES, EXPRESS OR IMPLIED, INCLUDING ANY IMPLIED WARRANTIES OF MERCHANTABILITY OR FITNESS FOR A PARTICULAR PURPOSE.

© 2023 CARFAX, Inc., part of S&P Global. All rights reserved.
11/14/23 10:20:47 PM (CST)

